









-  **ATTENZIONE**
- Controllare l'integrità del piatto doccia prima di installarlo.
-  **ATTENTION**
- Check that the shower plate is not damaged before installing it.
-  **PRECAUCIÓN**
- Verifique que el plato de ducha no esté dañado antes de instalarlo.
-  **ACHTUNG**
- Überprüfen Sie die Integrität des Tanks vor dem Einbau.

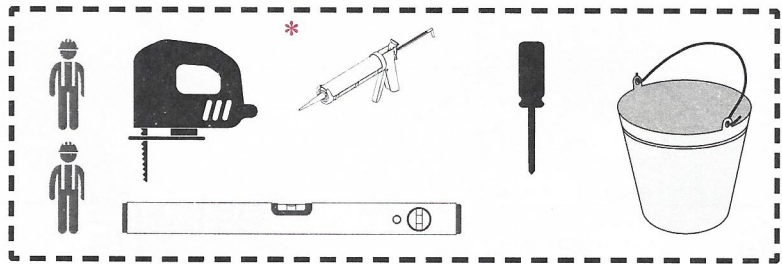
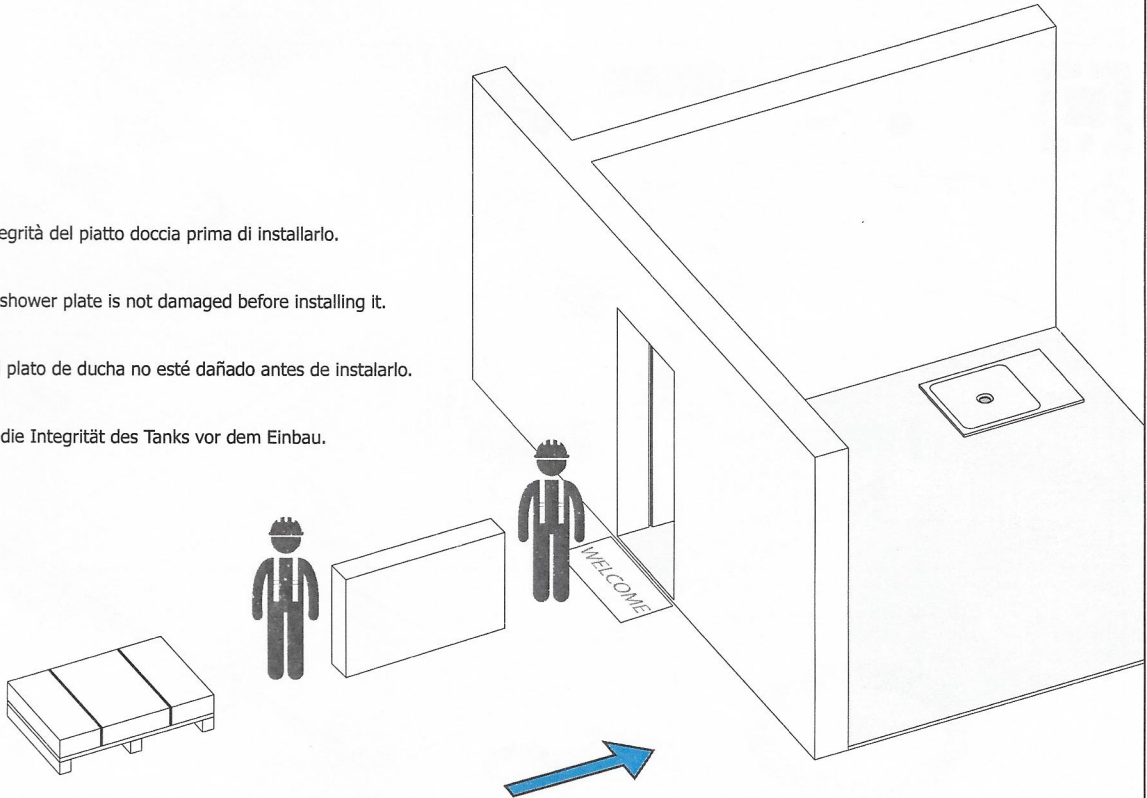

*** ATTENZIONE**

 - Utilizzare il silicone solo in caso di piatto autoportante e pavimento livellato. In esistenza di altre situazioni, usare una schiuma poliuretana non espansiva.

 **ATTENTION**
- Use silicone only in case of self-supporting plate and levelled floor. In other cases, use a non-expansive polyurethane foam.

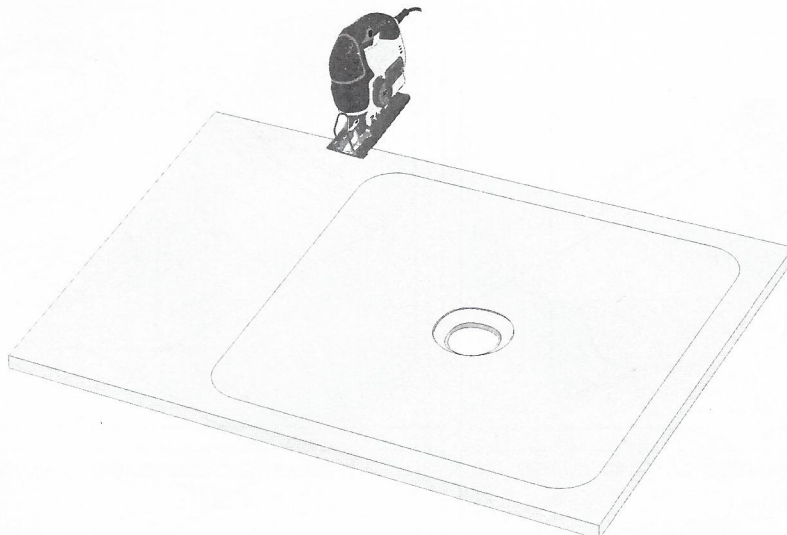





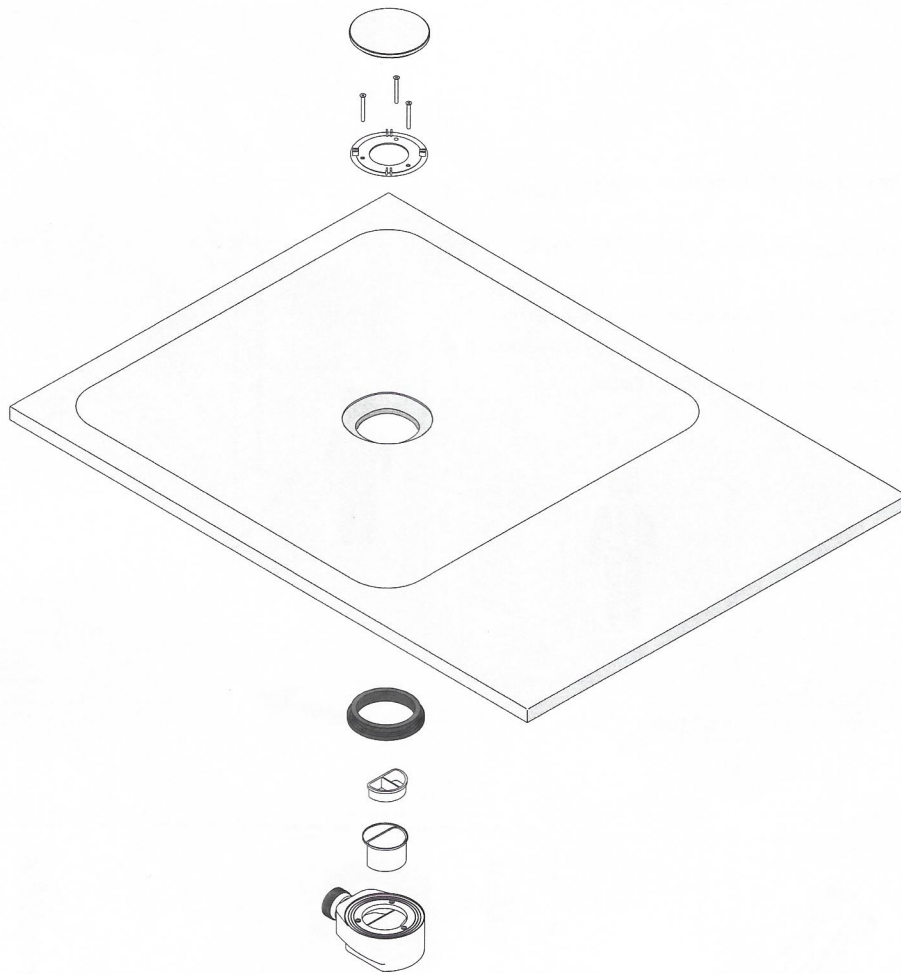

A





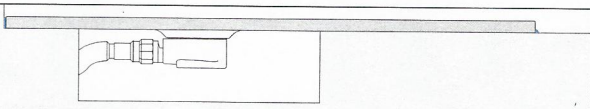
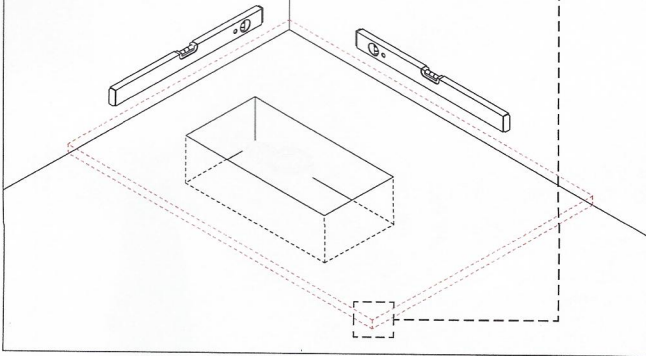
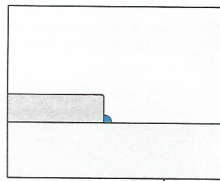

B₁

-  VERSIONE A PAVIMENTO
-  FLOOR-LEVEL SHOWER PLATE
-  PLATO DE DUCHA A RAS DE SUELO
-  BODEN AUSFÜHRUNG



B₂



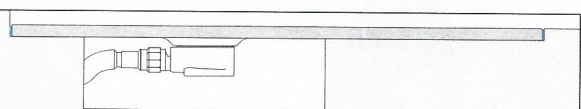
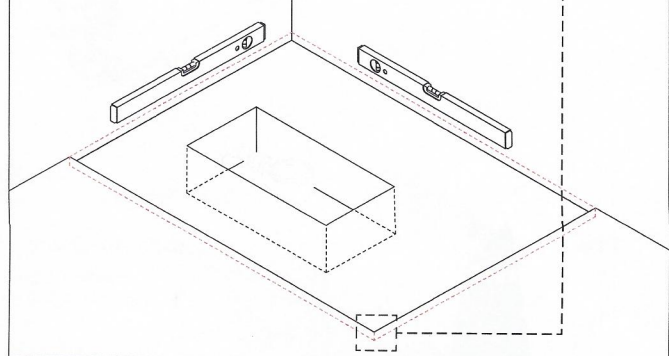
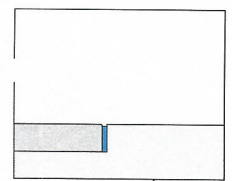

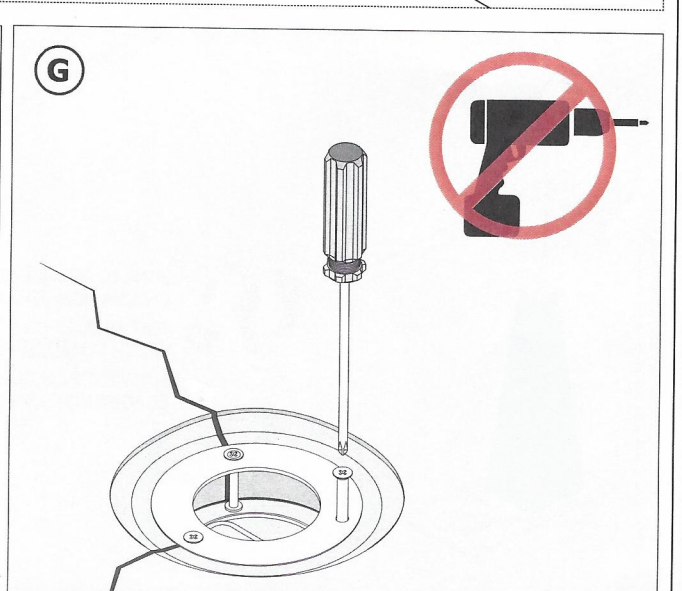
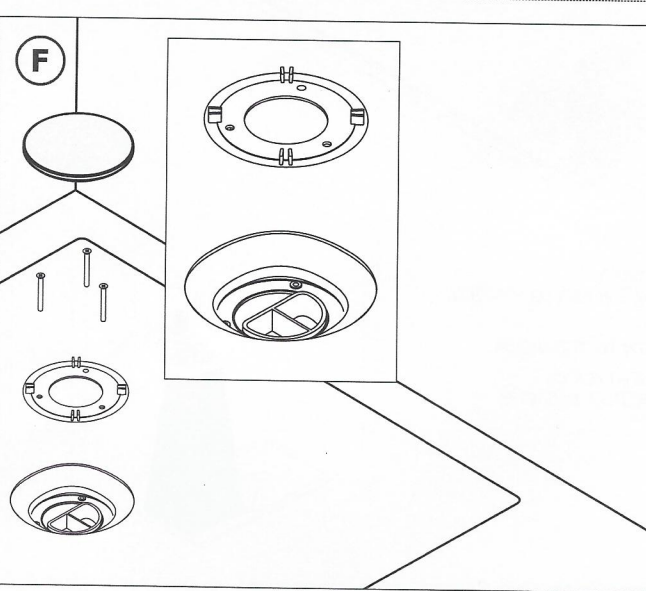
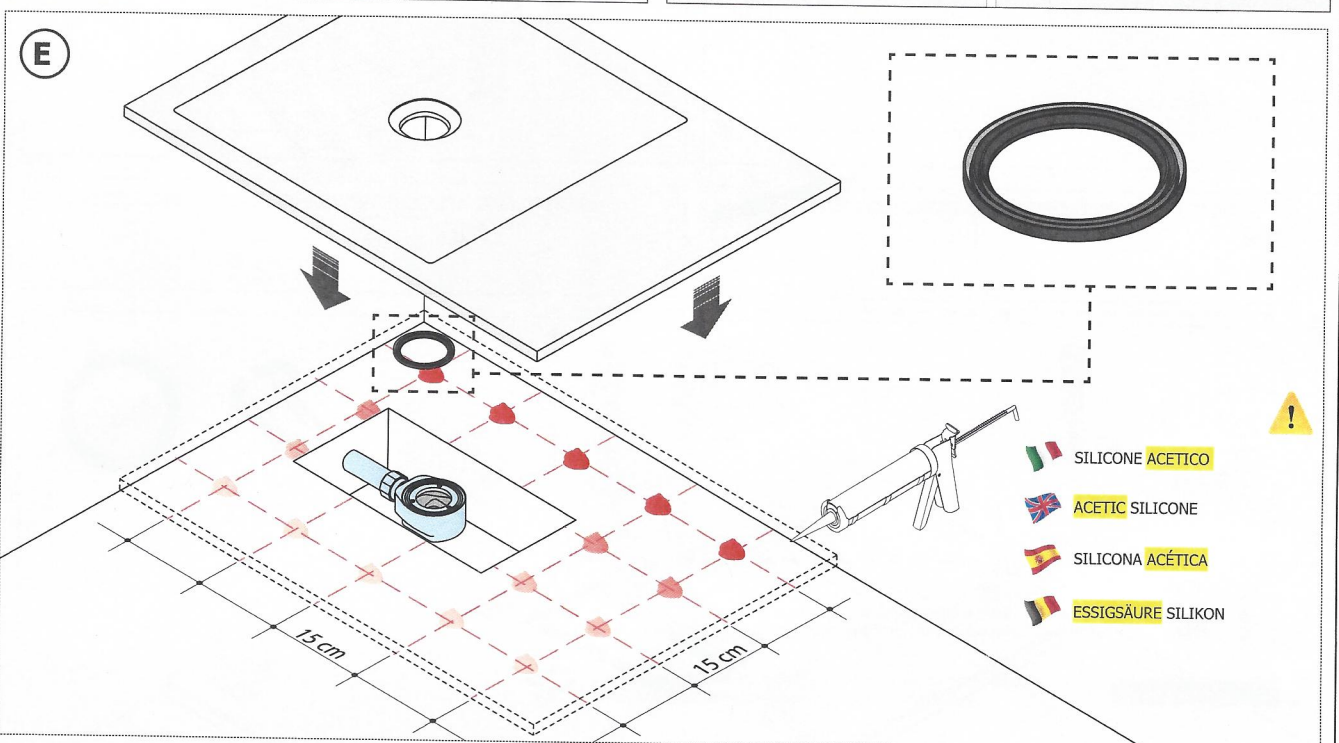
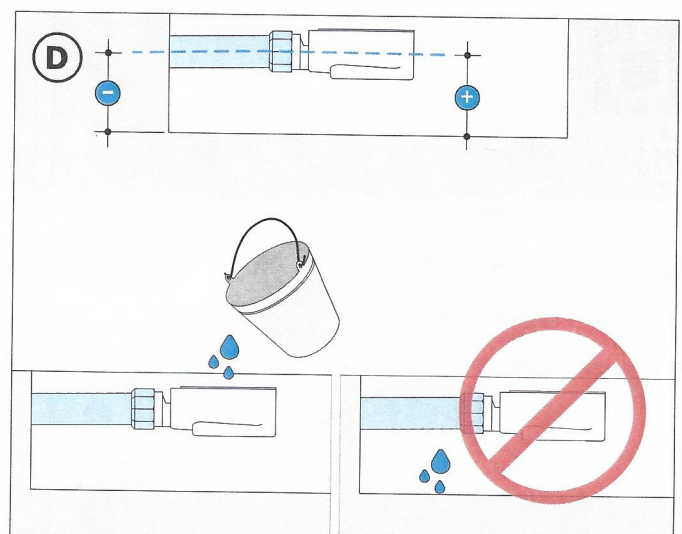
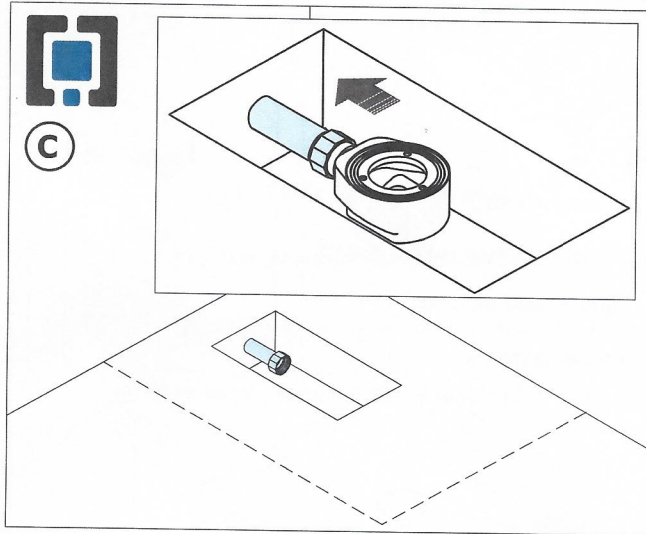
-  VERSIONE INCASSO
-  SHOWER PLATE BELOW FLOOR LEVELPLATE
-  PLATO DE DUCHA ENCAJADO
-  EINGEBAUTE VERSION









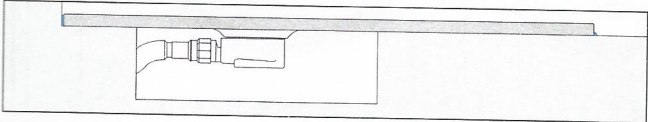
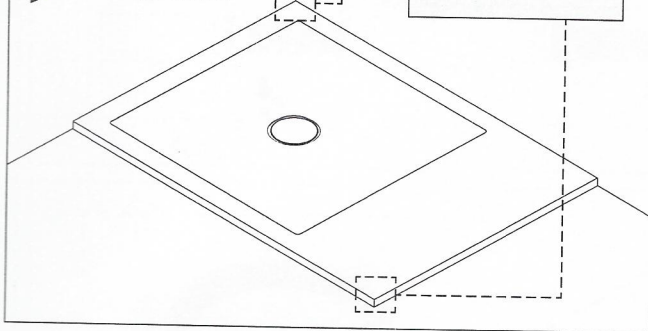
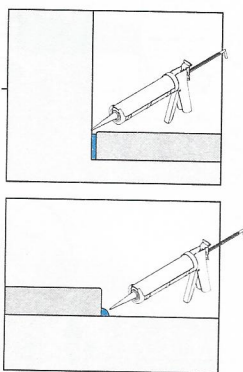

H₁



-  VERSIONE A PAVIMENTO
-  FLOOR-LEVEL SHOWER PLATE
-  PLATO DE DUCHA A RAS DE SUELO
-  BODEN AUSFÜHRUNG

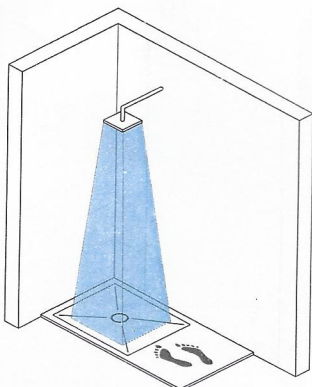
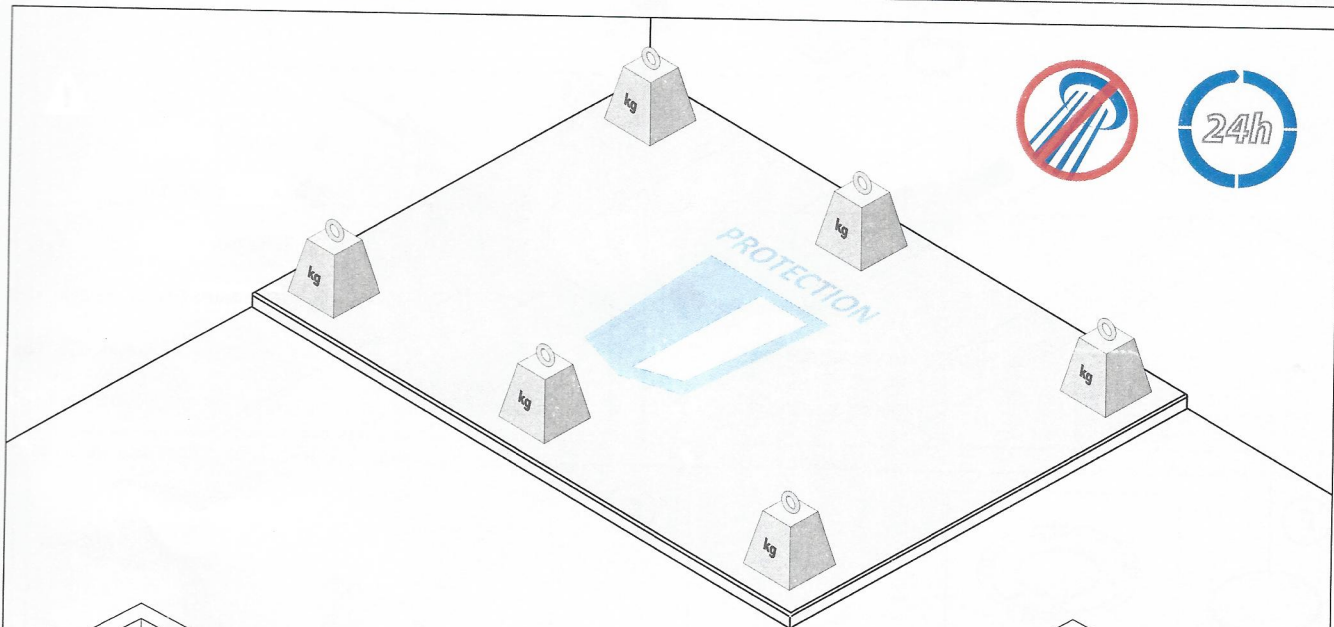
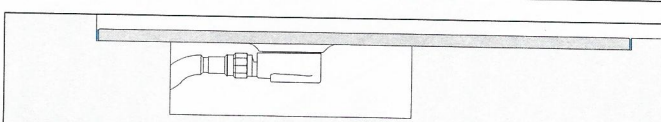
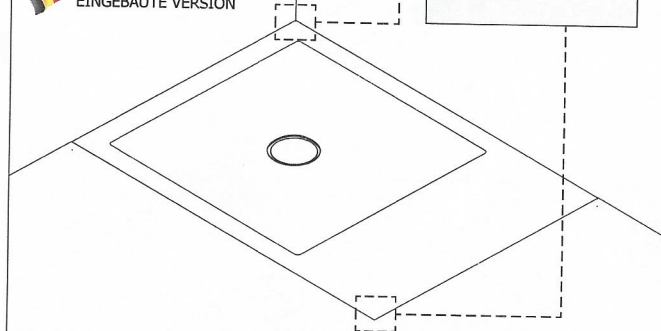
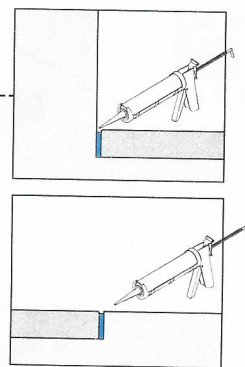

H₂

-  VERSIONE INCASSO
-  SHOWER PLATE BELOW FLOOR LEVELPLATE
-  PLATO DE DUCHA ENCAJADO
-  EINGEBAUTE VERSION



-  ZONA DI PASSAGGIO PIANA.
L'ACQUA NON DEFLUISCE VERSO LO SCARICO.
-  FLAT AREA.
WATER DOES NOT FLOW TO THE DRAIN.
-  SUPERFÍCIE DE TRÁNSITO PLANA.
EL AGUA NO FLUYE HACIA EL DESAGÜE.

