

DIVA

140 x 140

TECHNICAL DATA SHEET

HAFRO

WELLNESS & SHOWER

The installation of the tub must be carried out by qualified personnel for both the electrical and hydraulic connections.

Before proceeding with the connection, the installer must check that the electrical system is protected by a differential switch (0.03) and that the earthing system complies with the regulations in force in the country of use.

The whirlpool tub must be connected to the electrical system in a fixed manner (with H05 - 3x2.5 mm² three-pole cable with a 2.5 mm² cross-section) via a bipolar switch (minimum contact opening 3 mm) suitable for the power (KW) of the product to be connected, placed outside zones 0,1,2,3 and away from possible splashes of water.

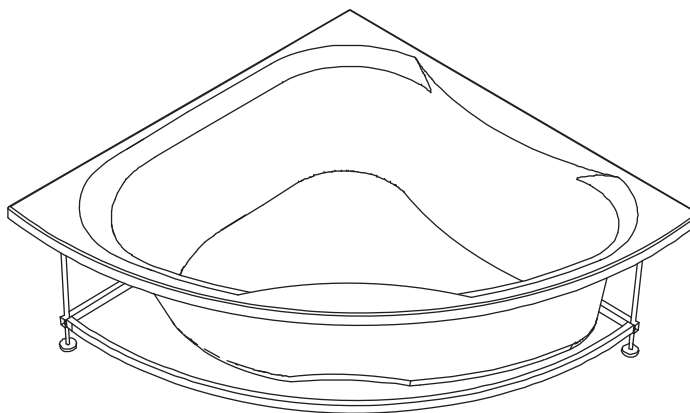

SYSTEMS	Electrical characteristics				Vents		Water cont.		Dimensions			Packaging dimensions			Weight	
	Volt	A	KW	Hz	Whirl.	Airpool	Use	Max	Lenght.	Width	Height	Lenght	Width	Height	Net	Gross
Tub with frame	-	-	-	-	-	-	190	240	140	140	59	147	147	74	40	66
Whirlpool	230	4.5	0.95	50	7	-	190	240	140	140	59	147	147	74	55	82
Digital Whirlpool	230	4.5	0.95	50	7	-	190	240	140	140	59	147	147	74	55	82
Airpool	230	3.0	0.7	50	-	16	190	240	140	140	59	147	147	74	47	74
Whirlpool airpool	230	7.5	1.7	50	7	12	190	240	140	140	59	147	147	74	62	89
Professional W-A	230	7.5/11.2*	1.7/2.45*	50	7	20	190	240	140	140	59	147	147	74	68	95

*With active heater.

The data does not include panels or accessories.

The product must also be connected to the building's equipotential bonding system using the appropriate terminal on the frame.

If the bathtub is installed within walls, the warranty will only be valid if adequate inspection and ventilation grilles are installed in the walls themselves. The bathtub must also be removable at any time, without requiring any work on the walls.

WARNING: Failure to comply, even partially, with the above conditions may compromise the safety of the tub: the warranty and the manufacturer's liability for any direct or indirect damage caused by the product will therefore lapse.

The forfeiture of the warranty, in the above-mentioned case, will result in the replacement of only those parts found to be defective, without covering the costs of labor required to remove the product.

Provide stopcocks outside the product to shut off the hot and cold water.

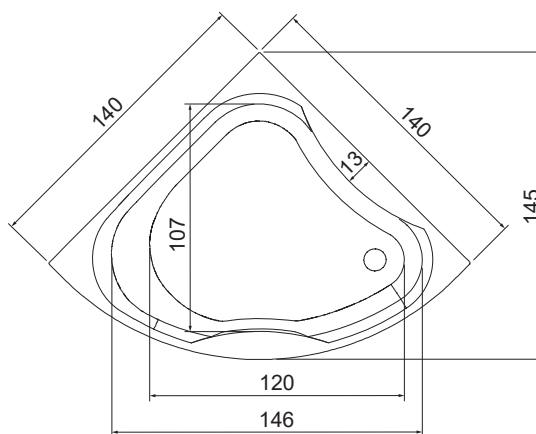

Dimensions are expressed in centimeters. Actual dimensions may vary by ± 0.5 cm.

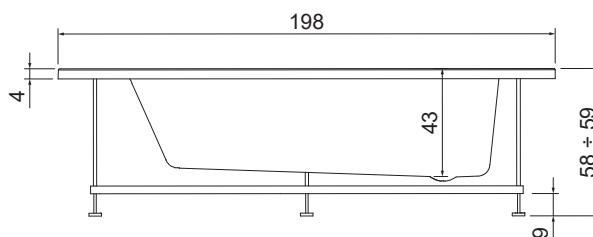

If the tub is installed inset, the wall must not extend more than 1 cm from the outer edge. Provide an inspection panel and air intake.

DIVA

140 x 140

ELECTRICAL AND HYDRAULIC PREPARATION

LEGEND

- A - 1/2" cold water connection.
- B - 1/2" hot water connection.



Operating pressure:
 - MIN 150 kPa (1,5 bar)
 - MAX 450 kPa (4,5 bar)



Hot water temperature:
 - MAX 60°C (140°F)

- A1 - Wall tap connection.
- C - Power cable output type H05 3x2.5mm² (min. length 2 [m])
- D - Equipotential cable output.
- E - Floor-level drain Ø 40.

NOTE:

For tubs with frames, do not include a power cable.

In all cases, always provide the equipotential bonding cable.

For the tub-mounted taps included in our catalog, use only connections A and B.

If a wall-mounted faucet (A1) is planned, consider the measurements shown in the drawing as the center of the faucet. The water inlet spout must be at least 5 cm higher than the edge.

If the water pressure is higher than indicated, install pressure reducers.

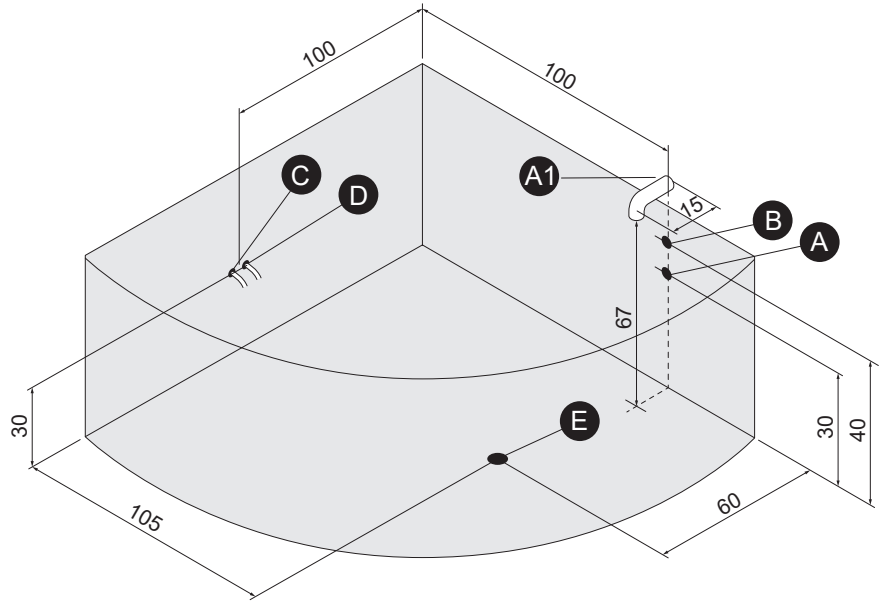

POSITIONING OF IGNITION CONTROLS AND TAPS

- A = Motor
- B = Blower
- C = Electrical control unit
- D = Keyboard

The position of the details A-B-C are different in tubs with accessories (heater).

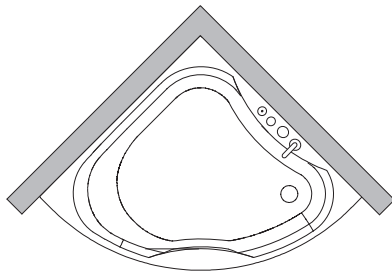

Taps

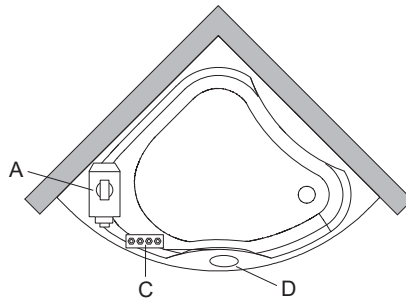

Whirlpool or Digital Whirlpool

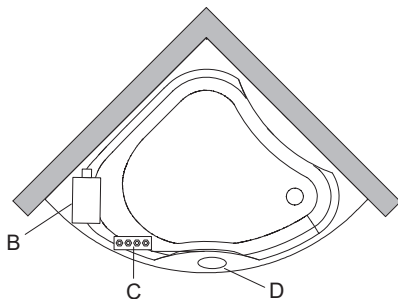

Airpool

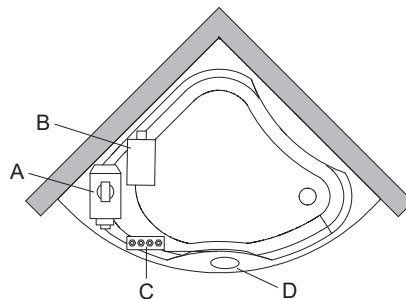

Whirlpool Airpool

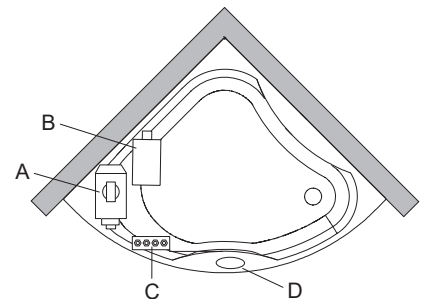

Professional Whirlpool Airpool