

CALLE OVAL 170x80 FREESTANDING

TECHNICAL DATA SHEET



The installation of the tub must be performed by qualified personnel for both regarding the electronic connection that for the hydraulic one. Before connecting the bath, the installer must see that the electrical system is protected by a circuit breaker (0.03) and that the earthing system complies with the laws in force in the country of installation.

The whirlpool bath must be connected to the electrical system permanently (with an H05 cable - 3x2.5 mm three pole with a 2.5 mm cross section) by means of a double-pole switch (minimum 3 mm opening between contacts) and suitably rated (KW) for the appliance to be connected, located away from areas 0,1,2,3 and from areas where jets of water are possible.

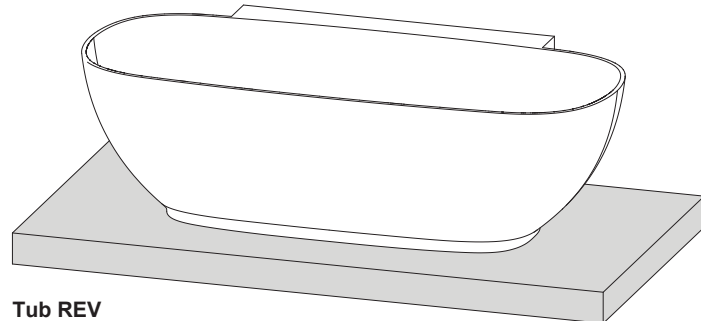

Tub REV

SYSTEM	ELETRICAL SPECIFICATIONS				JETS		WATER CONT.		PACKING DIMENSIONS				WEIGHT (KG)	
	Volt	A	W	Hz	Whirl.	Airl.	Use	Max	Lenght	Width	Height	Volume	Net	Gross
Tub with frame	-	-	-	-	-	-	275 l	370 l	180	90	71	1.15	122	137
Airpool	230	2	420	50-60	-	12	275 l	370 l	180	90	71	1.15	130	145

The overall dimensions are given in centimetres. Actual dimensions can vary by $\pm 0,5$ cm. The bath must also be connected to the building's equipotential earthing system by means of a terminal on the frame.

If the bath is to be recessed in walls, the guarantee will only be valid if the walls are fitted with inspection and aeration grids of a suitable size. It is also important that the bath can be taken out at any time without having to do anything to the walls.

WARNING:

If all or even part of the above described conditions are not complied with the safety of the whirlpool bath cannot be guaranteed and, as such, not only is the guarantee invalidated but also the manufacturer can in no way be held liable for any direct or indirect damages caused by the bath. In those cases where such conditions are not complied with, the guarantee will only cover the substitution of parts deemed defective and not the labour needed if the bath has to be removed.

Provide shut-off cocks out of the dimensions of the product for hot and cold water closing.

If the water pressure is higher than indicated, install pressure reducers.

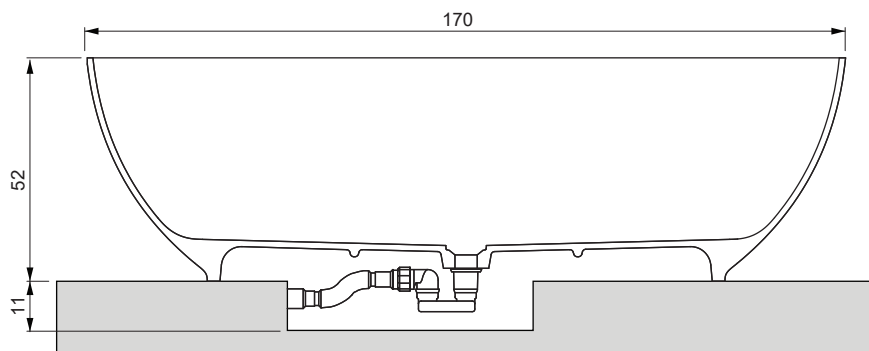
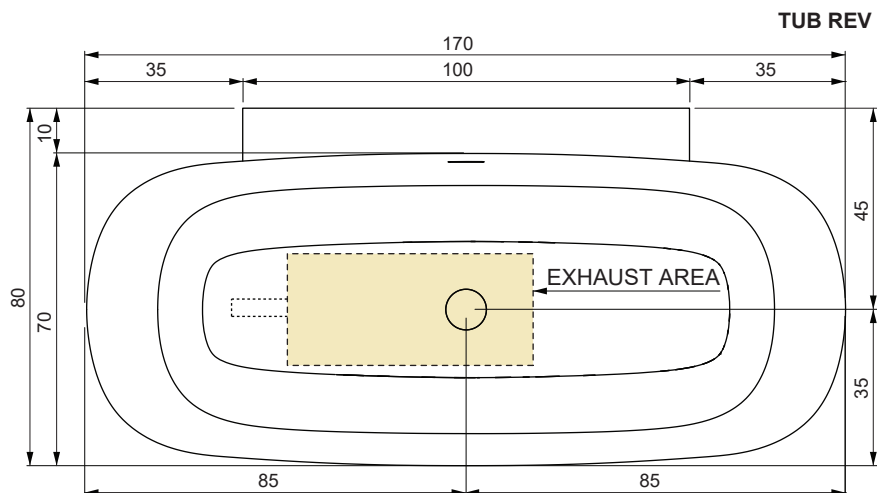

ELECTRIC AND HYDRAULIC PREPARATION

LEGEND

- A - 1/2 " cold water connection.
- B - 1/2 " hot water connection.



Operating pressure:
 - MIN 150 kPa (1,5 bar)
 - MAX 300 kPa (3,0 bar)



Hot water temperature:
 - MAX 60°C (140°F)

- C - Power cord output.
(minimum length 2 m).
- D - Equipotential cable output.
- S - Exhaust Ø40 mm.

NOTE

- For tanks with frame, do not provide power cord.
- In all cases always prepare the cable for the equipotential.
- For the bath tub taps in our catalog, use only A and B connections.

TUB REV

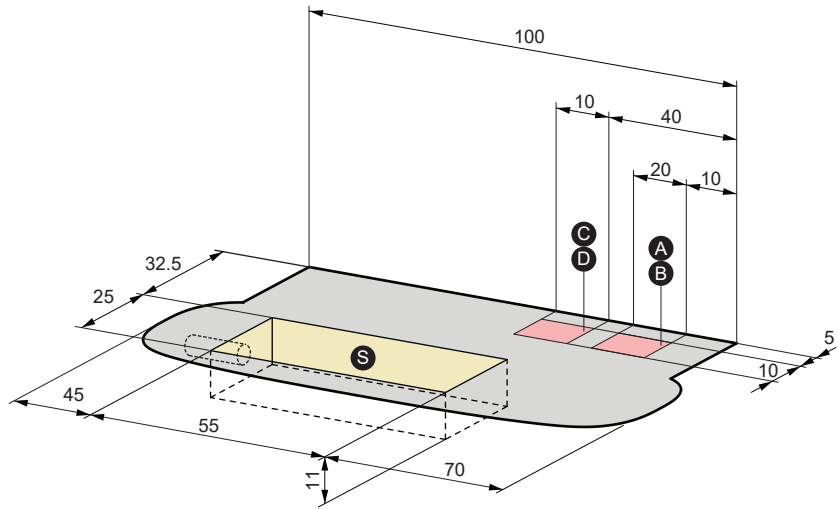
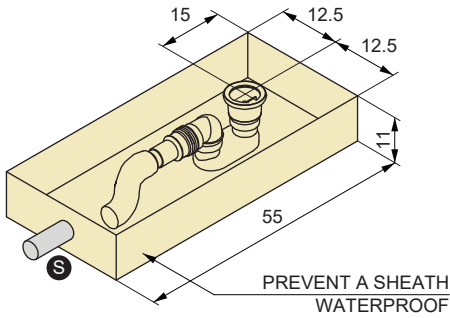

POSITIONING OF IGNITION CONTROLS AND TAPS

AIRPOOL

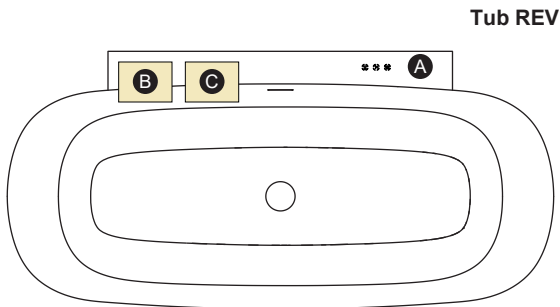

TAPS

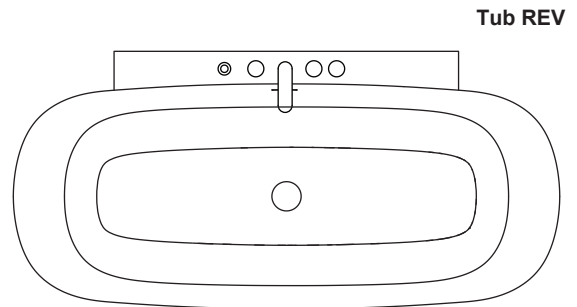

A	KEYBOARD
B	BLOWER
C	ELECTRIC POWER UNIT